

Speed Dome Camera Installation Guide



The product image shown above may differ from the actual product.
Please use this camera with a DVR which supports HD video recording.
Please read the instructions thoroughly before using the product.



CAUTION

RISK OF ELECTRIC SHOCK



CAUTION:

To reduce the risk of electric shock, do not expose this apparatus to rain or moisture.
Only operate this apparatus from the type of power source indicated on the label.

The company shall not be liable for any damages arising out of any improper use, even if we have been advised of the possibility of such damages.



The lightning flash with arrowhead symbol, within an equilateral triangle, is intended to alert the user to the presence of uninsulated "dangerous voltage" within the product's enclosure that may be of sufficient magnitude to constitute a risk of electric shock to persons.



This exclamation point within an equilateral triangle is intended to alert the user to the presence of important operating and maintenance (servicing) instructions in the literature accompanying the appliance.



ROHS Announcement

All lead-free products offered by the company comply with the requirements of the European law on the Restriction of Hazardous Substances (RoHS) directive, which means our manufacture processes and products are strictly "lead-free" and without the hazardous substances cited in the directive.



The crossed-out wheeled bin mark symbolizes that within the European Union the product must be collected separately at the product end-of-life. This applies to your product and any peripherals marked with this symbol. Do not dispose of these products as unsorted municipal waste.



CE Mark

This apparatus is manufactured to comply with the radio interference.

The company does not warrant that this manual will be uninterrupted or error-free. We reserve the right to revise or remove any content in this manual at any time.

TABLE OF CONTENTS

FEATURES	1
PACKAGE CONTENT	1
DIMENSIONS	1
CABLE OVERVIEW	2
INSTALLATION	3
CAMERA MODE, ID & BAUD RATE SETUP	5
WHERE TO SET	5
SET TO IP CAMERA.....	5
SET TO TVI CAMERA.....	5
INSERT A MICRO SD CARD	6
PTZ CONTROL	7
VIA HD CCTV DVR / NVR.....	7
VIA IP CAMERA INTERFACE	8
VIA JOYSTICK AVX102 (OPTIONAL).....	10
SPECIFICATIONS	11
MICRO SD CARD COMPATIBLE LIST	13

FEATURES

- Tribrid video output of **IP**, **TVI** and **AHD** to fulfill different customers' requirements
- Zoom lens of f4.7 ~ 94mm with **20x optical zoom and auto focus**, suitable for various monitoring environments
- **PTZ control** for seamless monitoring:
 - Capable of **360° pan rotation continuously** with the **tilt movement of -10° ~ 90°**, allowing quick and smooth action of the camera lens
 - **Auto Tracking** to follow moving objects
 - **Hot Point** support to quickly move the camera to the specified point remotely
 - Up to **256 preset points & four sequence groups** programmable for multiple points monitoring, and **auto pan**
- **External alarm I/O device** connection
- **ONVIF** () standard supported to simplify system integration
- MicroSD card support (up to 64GB) for **video storage**
- **WDR** to increase image recognizability in overexposure and dark areas
- **Line in / out** jacks available for audio transmission
- IR effective range up to **200 meters** for night surveillance, and **300 meters** available in the **IR Turbo** mode
- **IP66** for outdoor application
- **Remote Surveillance**
 - **Fully compatible** with **iOS** and **Android** devices, and **Internet Explorer** on Windows operating system
 - **Push Video** available on your iOS and Android devices when used with Push Video NVR series

PACKAGE CONTENT

- Camera ➤ User manual ➤ Bracket (w/carabiner) ➤ Terminal block

DIMENSIONS

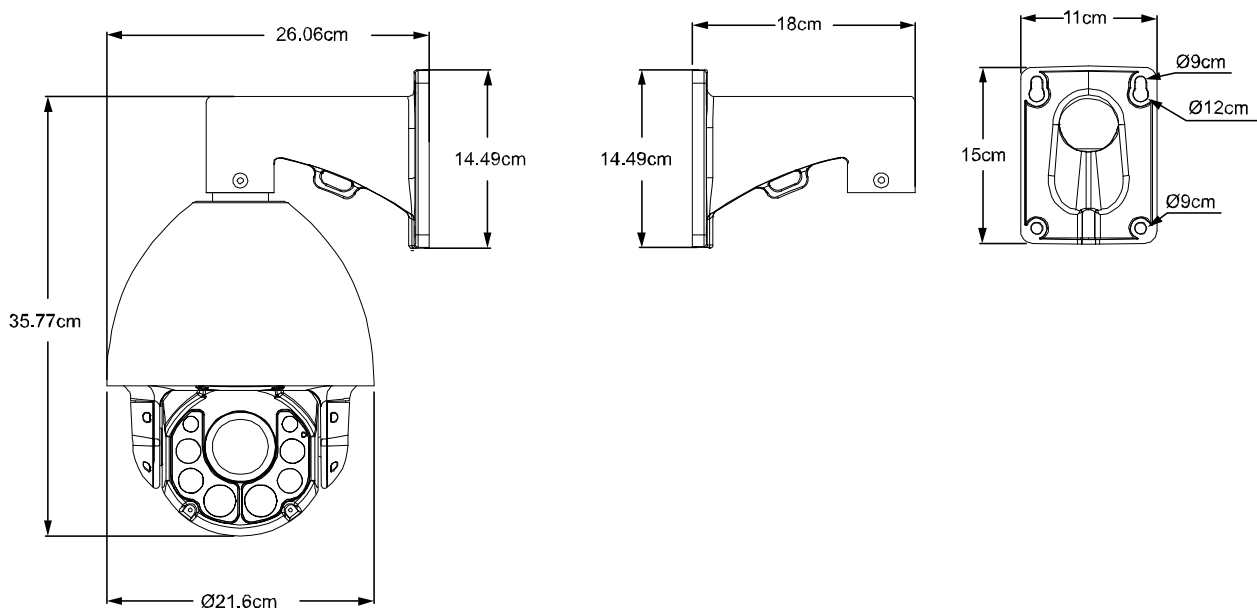

*Dimensional Tolerance: ± 5mm

CABLE OVERVIEW

Cable	Description
Power cable	Connect to the supplied adapter.
BNC cable	Connect to an HD CCTV DVR with a coaxial cable (Used as an HD CCTV camera).
Terminal block	
1. ALARM IN	Alarm input for an alarm device like magnetic contacts.
2. ALARM OUT	Alarm output for an alarm device like a siren.
3. GND	Ground wire
4. RS485A	Used for PTZ camera or other device connection.
5. RS485B	Used for PTZ camera or other device connection.
RJ45 network cable	Connect to an NVR with a RJ45 network cable or directly connect to a router (Used as an IP camera).
Line in*	Colored as blue, used to connect to a microphone for audio input.
Line out*	Colored as green, used to connect to a speaker for audio output.
RESET	Remove the insulating coating of wire, and twist it with a ground wire together to reset default camera
GND	Ground wire

* The audio function is available only when this camera is used as an IP camera.

INSTALLATION

Step1: Set the camera mode, ID and baud rate as needed.

NOTE: This camera could be used as an IP camera, a TVI camera or an AHD camera. You need to manually set the camera for this device to work properly. For details, please check the section, "**CAMERA MODE, ID & BAUD RATE SETUP**".

Step2: Locate to where you want to install this camera and drill 4 holes for bracket installation. (**Figure 1**)

NOTE: Drill one hole for the cable to go through if necessary.

Step3: (Optional) Insert a microSD card for local recording.

NOTE: The recording function is available only when the camera is used as an IP camera. For details, please check the next section, "**INSERT A MICRO SD CARD**".

Step4: Pass the cables on the camera through the bracket and hook them together with the carabiner and wire. (**Figure 2**)

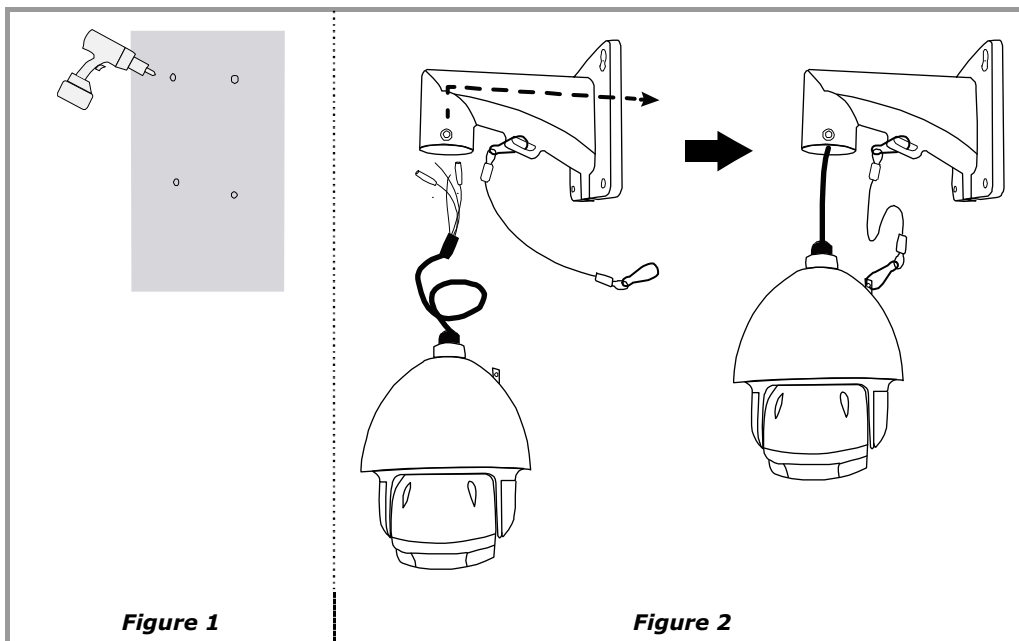

Step5: Lean them against the wall where you want to install this camera.

Arrange the cables to the down side of the bracket or through the wall. (**Figure 3**)

Step6: Screw the bracket onto the wall. (**Figure 4**)

NOTE: You might need another hand to hold the camera in this step.

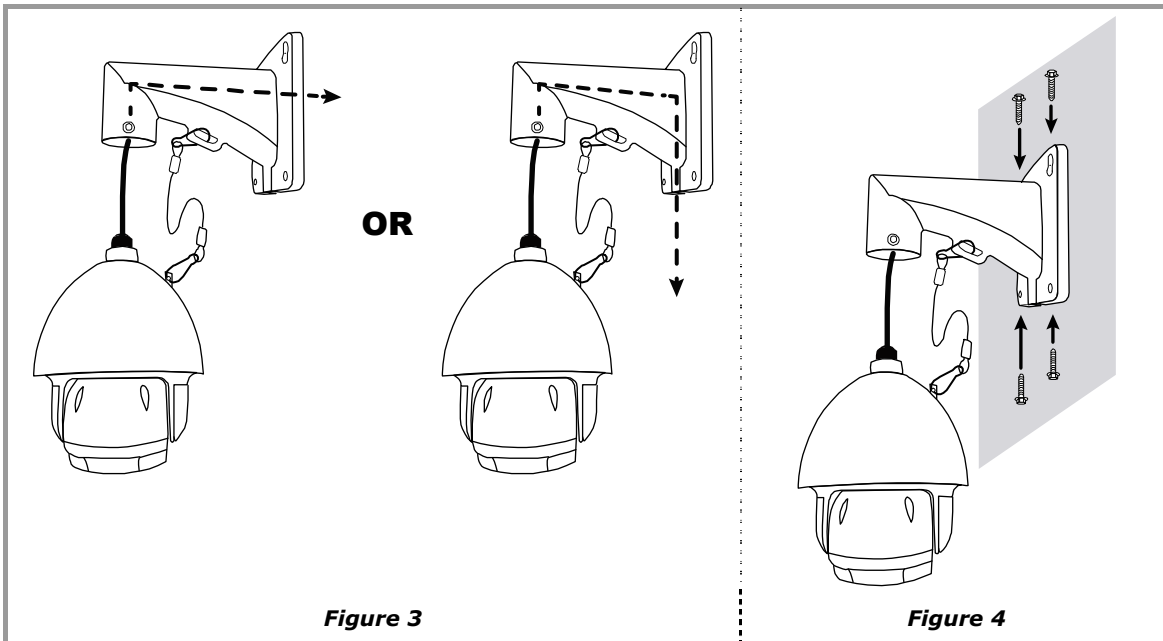

Step7: Screw the bracket and camera together. (**Figure 5**)

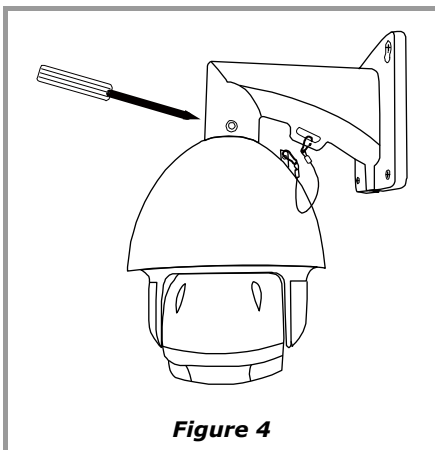

CAMERA MODE, ID & BAUD RATE SETUP

This camera could be used as an IP camera, a TVI camera and an AHD camera. Before connecting this camera to any recorder, you may need to manually set the camera mode, ID & baudrate for the camera to work properly. Please check the description below for details.

■ WHERE TO SET

Remove the panel as indicated below to find the dip switch.

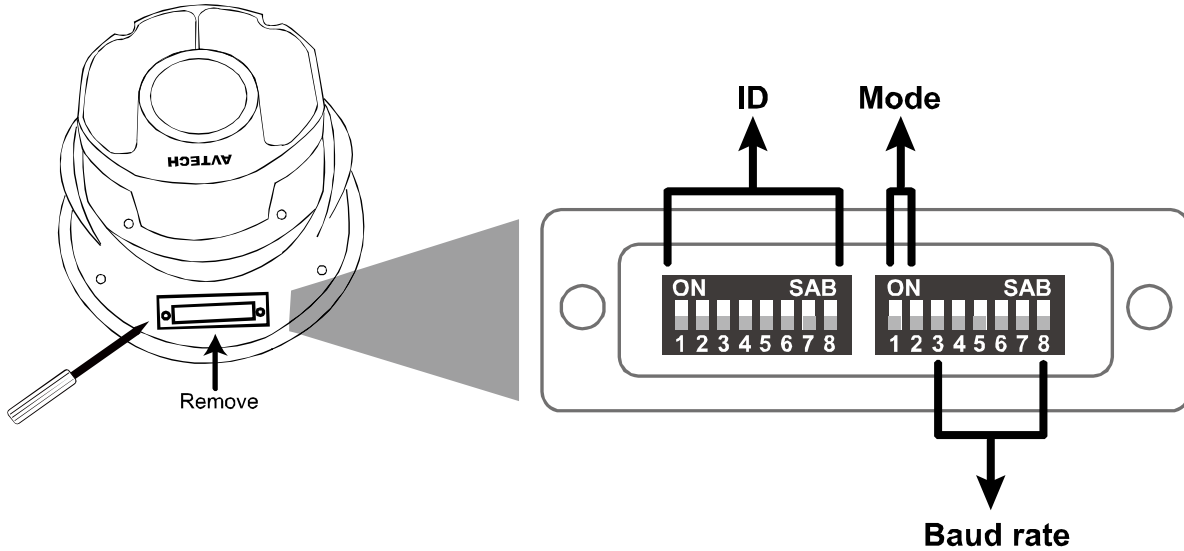

■ SET TO IP CAMERA

Mode: Mode: IP + CVBS
 1 = ON
 2 = ON

Mode: IP + Audio
 1 = OFF
 2 = OFF

■ SET TO TVI CAMERA

Mode: Mode: TVI
 1 = OFF
 2 = ON

You might need to set the ID and baud rate if you're connecting to other brand's TVI DVR:

ID: The ID number can be set from 0~255 (binary). Please check the examples below.

Default ID: 0 ID: 76 ID: 8

Baud Rate: 2400 4800 9600

■ SET TO AHD CAMERA

Mode: Mode: AHD **ON** **SAB**
 1 = ON
 2 = OFF



You might need to set the ID and baud rate if you're connecting to other brand's AHD DVR:

ID: The ID number can be set from 0~255 (binary). Please check the examples below.

Default ID: 0 ID: 76 ID: 8

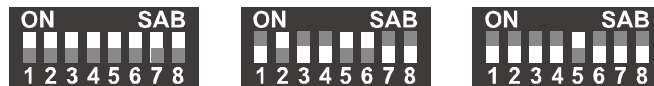

Baud Rate: 2400 4800 9600



19200 38400



INSERT A MICRO SD CARD

NOTE: A microSD card could be inserted to the camera for local recording, but the recording function is available only when the camera is used as an IP camera, not a TVI or AHD camera.

The data originally saved in the microSD card (if any) will be removed after inserting it into the camera.

The camera doesn't support hot-swapping. Please insert or remove the microSD card with power disconnected.

Please follow the directions in the below graphic to insert MicroSD card properly.

Step1: Remove the four screws. Then remove the plastic hull.

Step2: After opening the camera hull, you can see the inner structure.

As the below illustration shows, insert the SD card face down into the slot.

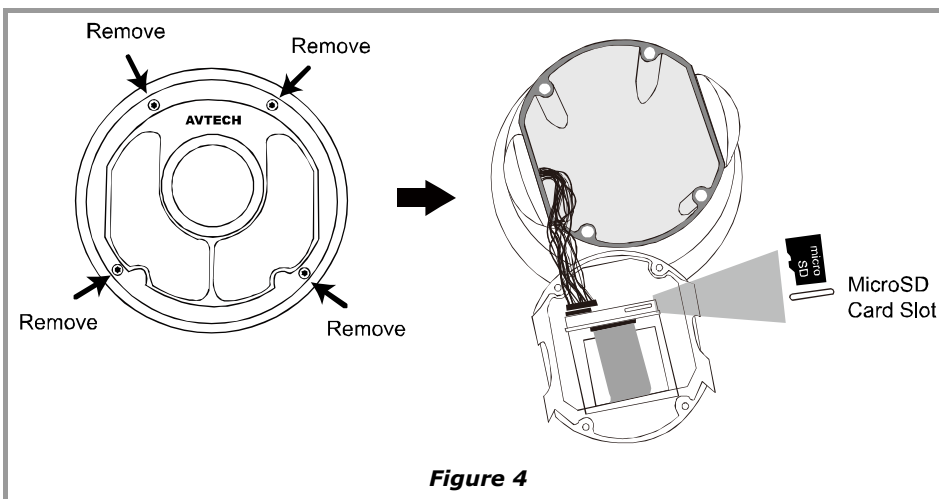

Step3: Replace the hull back, and make sure it's fastened tightly to ensure the waterproof function works properly.











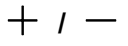

PTZ CONTROL

■ VIA HD CCTV DVR / NVR

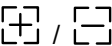
NOTE: The panel below is available only when the camera is used with our brand's HD CCTV DVR or NVR, and not all functions in the panel are supported for this camera.

Right-click to return to the live view, and click the channel with this speed dome camera connected. Then, click  on the bottom left side of the screen to show the PTZ control panel.



	Up / Down / Left / Right	Click the arrow keys ( /  /  / ) to move the camera lens up / down / left /right.
	Zoom in / out max	Click to zoom in on the image to the largest / zoom out on the image to its original size.
	Zoom in / out	Click to zoom in / out the image.
	Focus near / far	Click to adjust the focus of the image.
	Auto mode	Click to activate the auto function. Before using it, you need to assign a specific function that will be enabled when "  " is clicked. For details, please see "CAMERA PARAMETERS".
	Auto tracking	Click to start auto tracking, and click again to stop.
	Preset point	Click to configure or go to the preset point you want to see. For details, please see "SEQUENCE SETUP".
	Auto Focus	Click to automatically adjust the focus of the camera.

NOTE: PTZ control is also available via the optional USB joystick and EagleEyes. For details, please check their respective user manuals.

■ VIA IP CAMERA INTERFACE

When this camera is individually used and is not connected to any NVR, PTZ control can be done via the interface of the camera.

Step1: Open your web browser, and key in <http://ipaddress:portnum> in the URL address box.

For example, for the IP address 60.121.46.236 and port No. 888, please key in "http://60.121.46.236:888" into the URL address box, and press "Enter".

Step2: In the login page, key in the user name and password, and enter the security code from the image below if any. Then, click "LOGIN".

Step3: The wizard is then started.













- To skip the wizard and directly access the camera live view, click "Close".
- To directly access the camera live view without starting the wizard for the login next time, check "Do not start wizard at login".

Note: If you're prompted to install "VLC player", "Software" or "H264 Streaming Viewer", please agree to proceed the installation. Or, you might not be able to see the live view properly.

Step4: When the login is successful, the live view is shown.

Note: The buttons available depend on the camera model you have, and the user level used to log in.

The screenshot displays the web interface for an H.264 IP camera. On the left is a PTZ control panel with a directional pad and a numeric keypad. The main area shows a live video feed of an office. A red box at the top of the video feed contains streaming information: "FR:23.50 fps DR:5020 kbps Time:2014/10/07 21:32:16 Q:High R:HD1080P". A legend titled "Current Streaming Information" defines the abbreviations: FR: Frame rate, DR: Data rate, Time: Current system time, Q: Quality, R: Resolution. A red arrow points from this legend to the information box. Below the video feed is a zoom slider. Two red arrows point to the top and bottom edges of the video frame, labeled "Horizontal move" and "Vertical move" respectively. The interface also shows a "Zoom x3, DZ" label and "IPCAM Zoom x1, DZ x1" in the bottom right corner of the video area.

Function	Icon	Description
Config.		Switch to the system configuration page, and the functions available for “Supervisor” and “Power User” are different. For details, please refer to the user manual.
Arrow keys panel	--	Click to move the camera lens up / up-left / down / up-right / left / down-right / right / down-left.
Preset points	--	Click the numbering of the preset point you want to move the PTZ camera to the selected preset point. To set preset points, please go to “Config”. For details, please refer to the user manual.
Zoom-in / out	 / 	Click to zoom in / out the current image.
Max. Zoom-in / out	 / 	Click to zoom in the image to the largest / zoom out the image to its original size.
Focus near / far	 / 	Click to adjust the clearness of the video images.
DPTZ		Click to enable digital PTZ functions with zoom-in ratio up to 16X.
Auto Tracking		Click to activate the auto tracking function. For setting details, please go to “Config”. For details, please refer to the user manual.
Auto Mode		Click to activate the auto function. Before using it, you need to assign a specific function that will be enabled when “AUTO” is clicked. For details, please refer to the user manual. <i>This function will be disabled when DPTZ is enabled.</i>
Focus Zone		Click to assign the point for focus adjustment. <i>This function will be disabled when DPTZ is enabled.</i>
Auto Move		Click to enable the auto move function. It allows the camera to move to the direction where your cursor stays. <i>This function will be disabled when DPTZ is enabled.</i>

Pan- / Tilt-Move Manually

There are three ways to manually move the camera view by:

- Using the arrow key panel
- Hot point – Directly click on the live view to move the camera view.
- Using sliders – Click and drag sliders on the top and left side of the live view to move the camera view.

NOTE: PTZ control is also available via the optional USB joystick and EagleEyes. For details, please check their respective user manuals.

■ VIA JOYSTICK AVX102 (OPTIONAL)

When this camera is connected to our brand's DVR or NVR, simply plug the joystick to the recorder, switch to the channel which connects this camera and you're ready to control via the joystick.

When this camera is connected remotely via our free PC program, **CMS Lite**, simply plug this joystick to your PC or laptop, switch to the channel which connects this camera, and you're ready to control via the joystick.

NOTE: CMS Lite could be downloaded from our official website and it's only compatible with Windows XP, Windows Vista, Windows 7 and Windows 8. For details, please check our website.

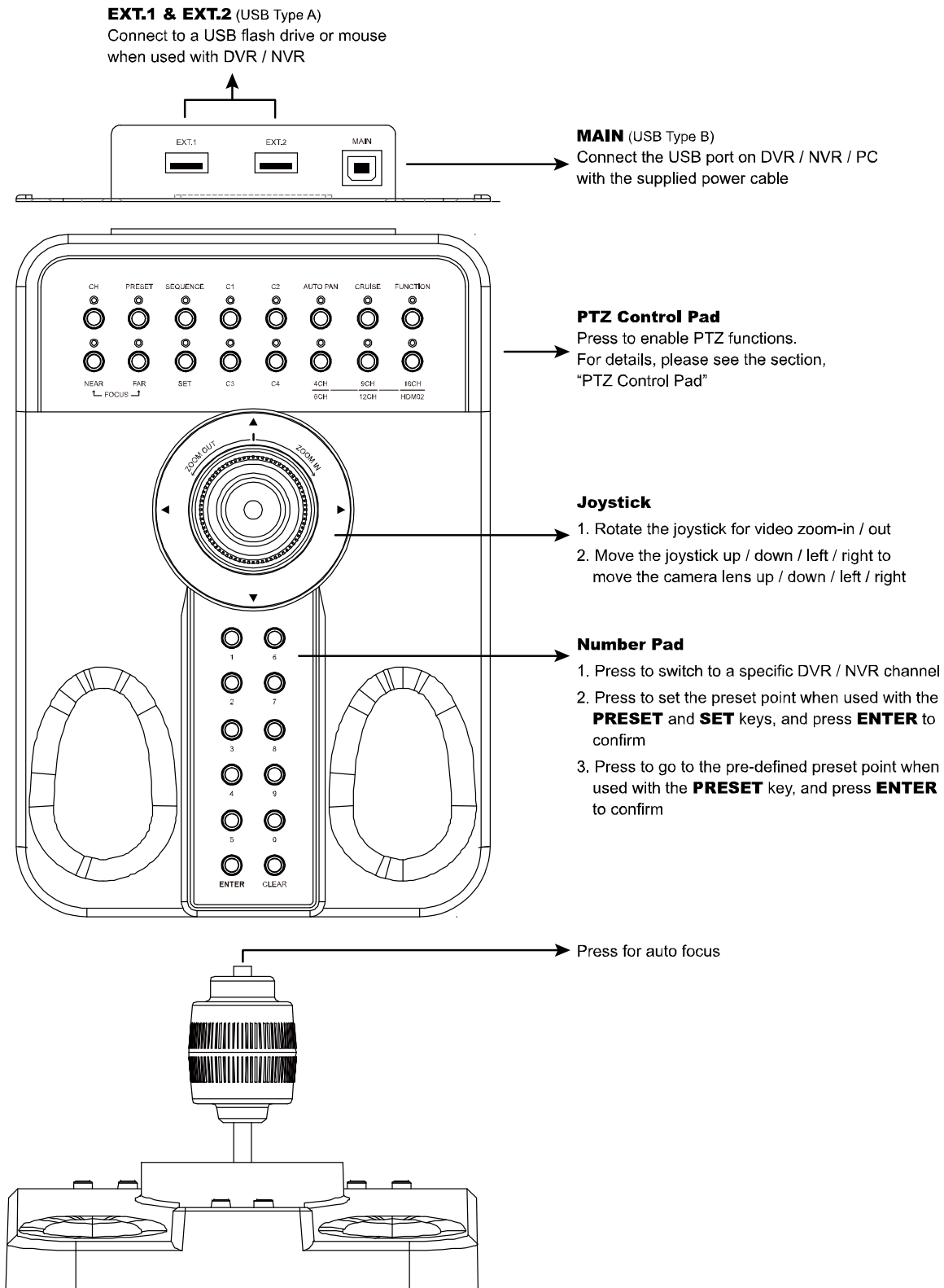

SPECIFICATIONS

■ Network

LAN Port	YES
LAN Speed	10/100 Based-T Ethernet
Data Transmission Speed	10/100/1000 Based-T
Supported Protocols	DDNS, PPPoE, DHCP, NTP, SNTP, TCP/IP, ICMP, SMTP, FTP, HTTP, RTP, RTSP, RTCP, IPv4, Bonjour, UPnP, DNS, UDP, IGMP, QoS, IEEE802.1X, SNMP
ONVIF Compatible	YES (Profile S)
Number of Online Users	10
Security	(1) Multiple user access levels with password (2) IP address filtering (3) Digest authentication
Remote Access	(1) Internet Explorer on Windows operating system (2) 16CH Video Viewer on Windows & MAC operating system (3) EagleEyes on iPhone, iPad & Android mobile devices

■ Video

Video Output	IP, TVI*, AHD* and CVBS
Compression Format	H.264 (Main Profile) / MJPEG
Video Resolution	1920 x 1080 / 1280 x 720 / 720 x 480 / 352 x 240
Frame Rate	30 fps
Multiple Video Streaming	4 (H.264, MJPEG)
Bitrate Control	SVBR control (VBR + Max bitrate)

■ General

Image Sensor	1/2.8" Sony CMOS image sensor
Min Illumination	0.1 Lux / F1.6(Wide)~F3.5(Tele), 0 Lux (IR LED ON)
Shutter Speed	1 / 60 (1/50) to 1 / 100,000 sec.
S/N Ratio	More than 48dB (AGC off)
Lens	f4.7 ~ 94mm / F1.6 (Wide) ~ 3.5(Tele), auto focus
Viewing Angle	1X: 60.8° (Horizontal) / 35.3° (Vertical) / 68.3° (Diagonal) 20X: 3.4° (Horizontal) / 1.9° (Vertical) / 3.8° (Diagonal)
IR LED	8units
IR Effective Distance	Default: Up to 200 meters / IR Turbo mode: Up to 300 meters
IR Shift	YES
Smart Light Control	YES
White Balance	Auto / 2500K / 3200K / 4200K / 5800K / 9500K
AGC	YES
IRIS Mode	YES
Sharpness	YES
WDR	YES
External Alarm I/O	YES (1 input / 1 output)
RAM	20MB
MicroSD Card Slot	YES (up to 64GB)
RS-485	YES
IP Rating (weather-proof)	IP66
Operating Temperature	-25°C ~ 50°C
Power Source (±10%)	AC 24V / DC19V
Current consumption (±10%)	DC19V / 1.3A
Power Consumption (±10%)	25W
Net Weight (kg)	6.9

■ Audio	
Line in	YES (Mono)
Line out	YES (Mono)
■ PTZ Mechanism	
Pan Range	360° continuous rotation
Max. Pan Speed	90°/s
Tilt Range	-10° ~ 90°
Max. Tilt Speed	70°/s
Zoom Ratio	20X Optical Zoom
Max. Zoom Speed	Approx. 3s (Tele ~ Wide)
Preset Points	Up to 256 preset points
Sequence Group	<ol style="list-style-type: none"> Up to four groups can be set One group can include up to 16 preset points
Auto Tracking	YES
■ Others	
Mobile Surveillance	iOS & Android
Event Notification	FTP / Email / SMS
Digital Pan / Tilt / Zoom	YES
Reset Default	YES
Motion Detection	YES
RTC (real-time clock)	YES
Minimum Web Browsing Requirements	<ul style="list-style-type: none"> Intel core i3 or higher, or equivalent AMD 2GB RAM AGP graphics card, Direct Draw, 32MB RAM Windows 8, Windows 7, Windows Vista & Windows XP, DirectX 9.0 or later Internet Explorer 7.x or later
Optional Peripherals	USB Joystick (AVX102)

* TVI and AHD output: 1.0 Vp-p composite, 75Ω

**The specifications are subject to change without notice.

MICRO SD CARD COMPATIBLE LIST

Manufacturer	Capacity	Class	Manufacturer	Capacity	Class
ADATA	2GB	--	Transcend	2GB	--
	4GB	Class 6		4GB	Class 2
Apacer	2GB	--		4GB	Class 4
	4GB	Class 4		4GB	Class 6
SanDisk	2GB	--		8GB	Class 6
	4GB	Class 4		16GB	Class 10
	8GB	Class 4	Kingston	2GB	--
	16GB	Class 4		4GB	Class 4
32GB	Class 4	8GB		Class 4	
Verico	2GB	--		32GB	Class 4
	4GB	Class 4	64GB	Class 10	
	16GB	Class 10	TOSHIBA	16GB	Class 4
Silicon Power	64GB	--	TOPRAM	32GB	Class 10
Kingmax	64GB	--			